

Waveshare  
Spot Pear

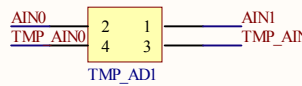
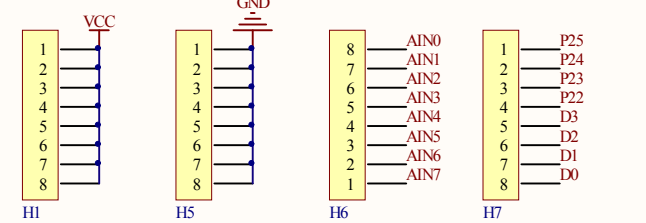
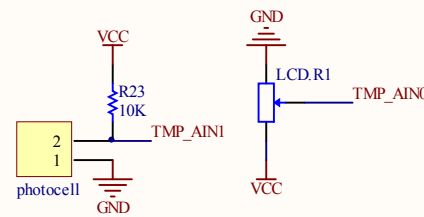
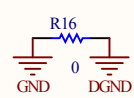
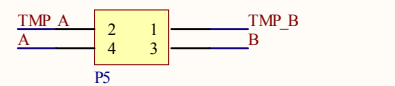
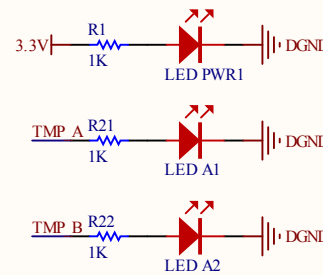
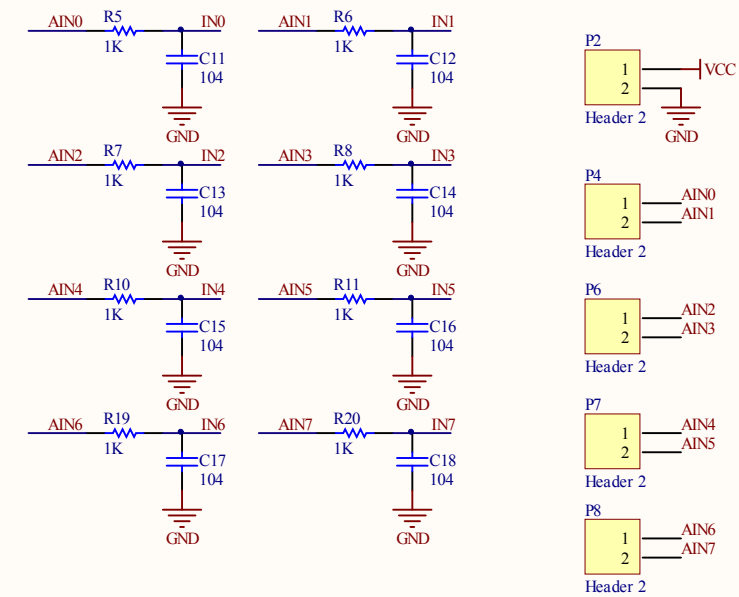
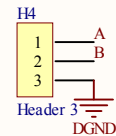

Title		
Size	Number	Revision
A4		
Date:	2015-10-31	Sheet of
File:	E:\High-Precision AD-DA Build Board BghDoc	

Comment	Description	Designator	Footprint	LibRef	Quantity
photocell	Header, 2-Pin	1	sun_r	Header 2	1
10UF	Capacitor	C1, C6, C8	ws_3225_1	Cap2	3
104	Capacitor	C2, C5, C7, C9, C10, C11, C12, C13, C14, C15, C16, C17, C18, C20, C21	0603	Cap	15
Header 8	Header, 8-Pin	H1, H5, H6, H7	SIP8	Header 8	4
Header 3	Header, 3-Pin	H4	3P-3.5mm	Header 3	1
120R	Resistor	L1, L2	0603	Res1	2
RES_ADJ		LCD.R1	PR	RES_ADJ	1
LED_0805		LED A1, LED A2, LED PWR1	0805_LED	LED_0805	3
waveshare_logo		logo1	WS_symbol_l	waveshare_logo	1
Header 3X2	Header, 3-Pin, Dual row	P1	Header 3x2	Header 3X2	1
Header 2	Header, 2-Pin	P2, P4, P6, P7,	2P-3.5mm	Header 2	5
Header2X2		P5, TMP_AD1	Header 2x2	Header2X2	2
Header 20X2	Header, 20-Pin, Dual row	PI	DIP20X2	Header 20X2	1
1K	Resistor	R1, R2, R5, R6, R7, R8, R10, R11, R19, R20, R21, R22	0603	Res1	12
49.9	Resistor	R3, R4	0603	Res1	2
100R	Resistor	R9, R12, R13, R14, R15, R25	0603	Res1	6
0	Resistor	R16	0603	Res1	1
10K	Resistor	R17, R18, R23	0603	Res1	3
SpotPear_logo		SpotPear_LOGO1	sp_symbol_200	SpotPear_logo	1
Header 2	Header, 2-Pin	TMP_COM	HDR1X2	Header 2	1
DAC8532		U1	ssop8	DAC8552	1
ADS1256		U2	SSOP28	ADS1256	1
LM285D-2.5		U3	soic8	LM285D-2.5	1
7.68M	Crystal Oscillator	X1	CRYSTAL2	XTAL0	1
18PF	Capacitor	XTAL1, XTAL2	0603	C_0805	2