

1

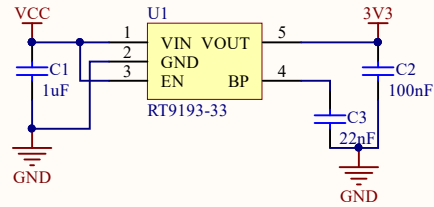

Power

2

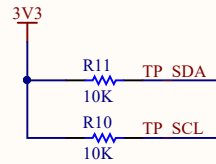

Level conversion

3

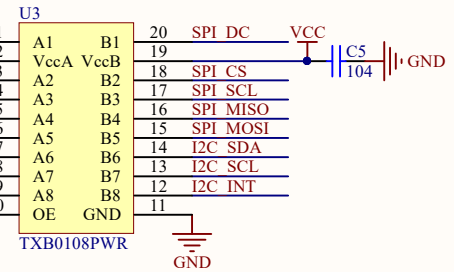
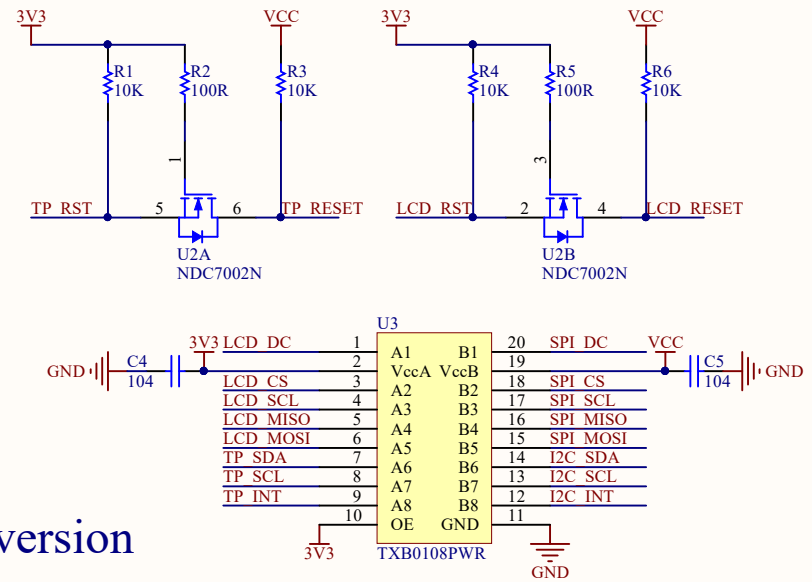

A

A

B

B

C

C

D

D

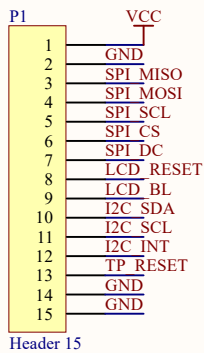

Interface

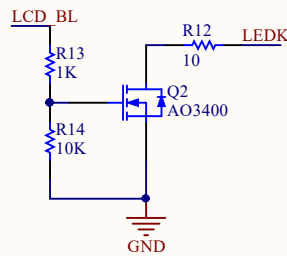

Touch LCD

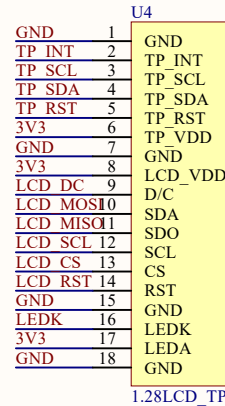

1.28inch Touch LCD

1

2

3

4

VCC
GND
MISO
MOSI
SCLK
LCD_CS
LCD_DC
LCD_RST
LCD_BL
TP_SDA
TP_SCL
TP_INT
TP_RST



C1 R12

U1 Q2

C3 R13

C2 R14

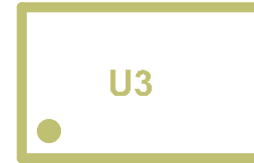
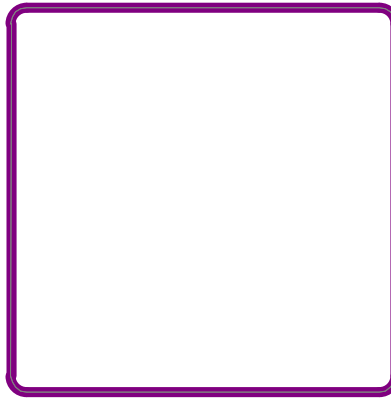

C5 C4 R11 R10



Waveshare

R3 R6 R1 U2 R4 R5 R2

1.28inch Touch LCD