



UART Fingerprint Sensor (C)

User Manual

CONTENT

Overview	2
Features.....	2
Specification	2
Hardware	4
Dimension.....	4
Interface	4
Commands	5
Commands format	5
Commands Types:.....	6
Communication process.....	13
Add fingerprint.....	13
Delete user.....	14
Delete all users.....	14
Acquire image and upload eigenvalue	15
User guides.....	16
Connect to PC	16
Hardware connection.....	16
Testing	17
Connect to XNUCLEO-F103RB	18
Connect to Raspberry Pi.....	18

OVERVIEW

This is a highly integrated round-shaped all-in-one capacitive fingerprint sensor module, which is nearly as small as a nail plate. The module is controlled via UART commands, easy to use. Its advantages includes 360° omni-directional verification, fast verification, high stability, and low power consumption, etc.

Based on a high-performance Cortex processor, combined with high-security commercial fingerprinting algorithm, the UART Fingerprint Sensor (C) features functionalities like fingerprint enrolling, image acquisition, feature finding, template generating and storing, fingerprint matching, and so on. Without any knowledge about the complicate fingerprinting algorithm, all you need to do is just sending some UART commands, to quickly integrate it into fingerprint verification applications which require small size and high precision.

FEATURES

- Easy to use by some simple commands, you don't have to know any fingerprint technology, or the module inter structure
- Commercial fingerprinting algorithm, stable performance, fast verification, supports fingerprint enrolling, fingerprint matching, collect fingerprint image, and upload fingerprint feature, etc.
- Capacitive sensitive detection, just touch the collecting window lightly for fast verification
- Hardware highly integrated, processor and sensor in one small chip, suit for small size applications
- Narrow stainless-steel rim, large touching area, supports 360° omni-directional verification
- Embedded human sensor, the processor will enter sleep automatically, and wake up when touching, lower power consumption
- Onboard UART connector, easy to connect with hardware platforms like STM32 and Raspberry Pi

SPECIFICATION

- Sensor type: capacitive touching
- Resolution: 508DPI
- Image pixels: 192×192
- Image grey scale: 8
- Sensor size: R15.5mm
- Fingerprint capacity: 500
- Matching time: <500ms (1:N, and $N \leq 100$)
- False acceptance rate: <0.001%
- False rejection rate: <0.1%
- Operating voltage: 2.7~3.3V
- Operating current: <50mA
- Sleep current: <16uA
- Anti-electrostatic: contact discharge 8KV / aerial discharge 15KV
- Interface: UART

- Baudrate: 19200 bps
- Operating environment:
 - Temperature: -20°C~70°C
 - Humidity: 40%RH~85%RH (no condensation)
- Storage environment:
 - Temperature: -40°C~85°C
 - Humidity: <85%RH (no condensation)
- Life: 1 million times

HARDWARE

DIMENSION

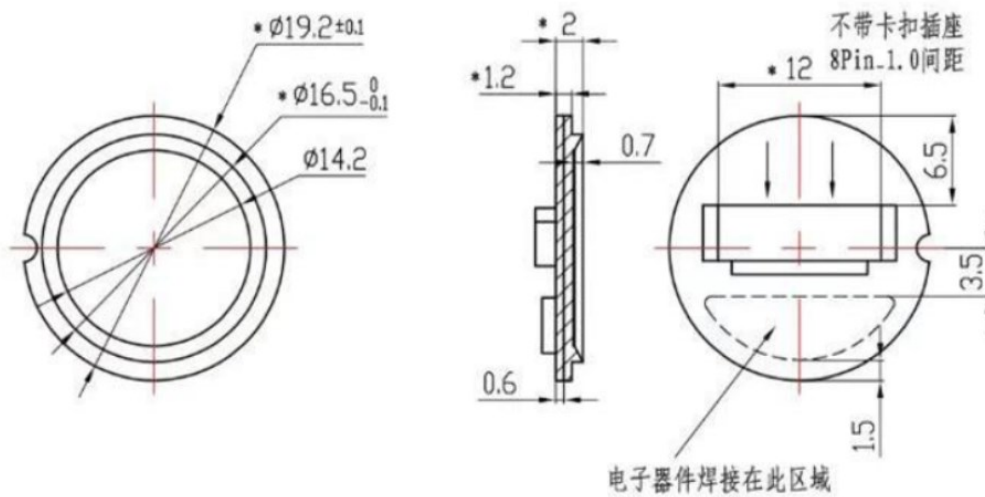

INTERFACE

Note: The color of actual wires may be different with the image. According to the PIN when connecting but not the color.

- VIN: 3.3V
- GND: Ground
- RX: Serial data input (TTL)
- TX: Serial data output (TTL)
- RST: Power enable/disable Pin
 - HIGH: Power enable
 - LOW: Power disable (Sleep Mode)
- WAKE: Wake up pin. When module is in sleep mode, WKAE pin is HIGH when touch sensor with finger.

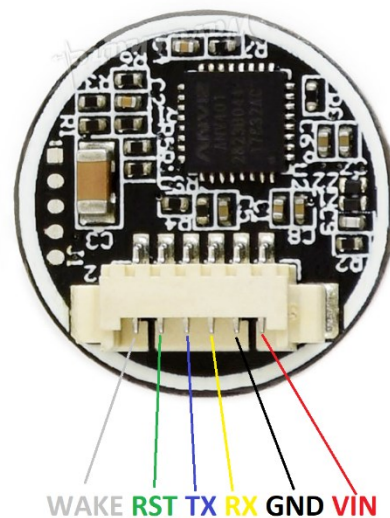

COMMANDS

COMMANDS FORMAT

This module works as slaver device, and you should control Master device to send commands to control it. Communicating interface is UART: 19200 8N1.

The format commands and responses should be:

1) =8 bytes

Byte	1	2	3	4	5	6	7	8
CMD	0xF5	CMD	P1	P2	P3	0	CHK	0xF5
ACK	0xF5	CMD	Q1	Q2	Q3	0	CHK	0xF5

Notes:

CMD: Type of command/response

P1, P2, P3: Parameters of command

Q1, Q2, Q3: Parameters of response

Q3: Generally Q3 is valid/invalid information of the operation, it should be:

```
#define ACK_SUCCESS      0x00 //操作成功
#define ACK_FAIL         0x01 //操作失败
#define ACK_FULL         0x04 //指纹数据库已满
#define ACK_NOUSER      0x05 //无此用户
#define ACK_USER_OCCUPIED 0x06 //用户已存在
#define ACK_FINGER_OCCUPIED 0x07 //指纹已存在
#define ACK_TIMEOUT     0x08 //采集超时
```

CHK: Checksum, it is XOR result of bytes from Byte 2 to Byte 6

2) >8 bytes. This data contains two parts: data head and data packet

data head:

Byte	1	2	3	4	5	6	7	8
CMD	0xF5	CMD	Hi(Len)	Low(Len)	0	0	CHK	0xF5
ACK	0xF5	CMD	Hi(Len)	Low(Len)	Q3	0	CHK	0xF5

Note:

CMD, Q3: same as 1)

Len: Length of valid data in data packet, 16bits (two bytes)

Hi(Len): High 8 bits of Len

Low(Len): Low 8 bits of Len

CHK: Checksum, it is XOR result of bytes from Byte 1 to Byte 6

data packet:

Byte	1	2...Len+1	Len+2	Len+3
CMD	0xF5	Data	CHK	0xF5
ACK	0xF5	Data	CHK	0xF5

Note:

Len: numbers of Data bytes

CHK: Checksum, it is XOR result of bytes from Byte 2 to Byte Len+1

data packet following data head.

COMMANDS TYPES:

1. Modify SN number of module (CMD/ACK both 8 Byte)

Byte	1	2	3	4	5	6	7	8
CMD	0xF5	0x08	New SN (Bit 23-16)	New SN (Bit 15-8)	New SN(Bit 7-0)	0	CHK	0xF5
ACK	0xF5	0x08	old SN (Bit 23-16)	old SN (Bit 15-8)	old SN (Bit 7-0)	0	CHK	0xF5

Notes: SN numbers is 24 bits constant.

2. Query Model SN (CMD/ACK both 8 Byte)

Byte	1	2	3	4	5	6	7	8
CMD	0xF5	0x2A	0	0	0	0	CHK	0xF5
ACK	0xF5	0x2A	SN (Bit 23-16)	SN (Bit 15-8)	SN (Bit 7-0)	0	CHK	0xF5

3. Sleep Mode (CMD/ACK both 8 Byte)

Byte	1	2	3	4	5	6	7	8
CMD	0xF5	0x2C	0	0	0	0	CHK	0xF5
ACK	0xF5	0x2C	0	0	0	0	CHK	0xF5

4. Set/Read fingerprint adding mode (CMD/ACK both 8 Byte)

There are two mode: enable duplication mode and disable duplication mode. When module is in disable duplication mod: same fingerprint could only added as one ID. If you want to add another ID with the same fingerprint, DSP response failed information. Module is in disable mode after powering on.

Byte	1	2	3	4	5	6	7	8
CMD	0xF5	0x2D	0	Byte5=0: 0:Enable 1:Disbale Byte5=1: 0	0: new mode 1: read current mode	0	CHK	0xF5
ACK	0xF5	0x2D	0	Current mode	ACK_SUCCUSS ACK_FAIL	0	CHK	0xF5

5. Add fingerprint (CMD/ACK both 8 Byte)

Master device should send commands triple times to module and add fingerprint triple times, make sure the fingerprint added is valid.

a) First

Byte	1	2	3	4	5	6	7	8
CMD	0xF5	0x01	User ID (High 8Bit)	User ID (Low 8Bit)	Permission (1/2/3)	0	CHK	0xF5
ACK	0xF5	0x01	0	0	ACK_SUCCESS ACK_FAIL	0	CHK	0xF5

					ACK_FULL ACK_USER_OCCUPIED ACK_FINGER_OCCUPIED ACK_TIMEOUT			
--	--	--	--	--	---	--	--	--

Notes :

User ID: 1~0xFFF;

User Permission: 1,2,3, (you can define the permission yourself)

b) Second

Byte	1	2	3	4	5	6	7	8
CMD	0xF5	0x02	User ID (High 8Bit)	User ID (Low 8Bit)	Permission (1/2/3)	0	CHK	0xF5
ACK	0xF5	0x02	0	0	ACK_SUCCESS ACK_FAIL ACK_TIMEOUT	0	CHK	0xF5

c) third

Byte	1	2	3	4	5	6	7	8
CMD	0xF5	0x03	User ID (High 8Bit)	User ID (Low 8Bit)	Permission (1/2/3)	0	CHK	0xF5
ACK	0xF5	0x03	0	0	ACK_SUCCESS ACK_FAIL ACK_TIMEOUT	0	CHK	0xF5

Notes: User ID and Permission in three commands.

6. Add users and upload eigenvalues (CMD =8Byte/ACK > 8 Byte)

This commands are similar to "5. add fingerprint", you should add triple times as well.

a) First

Same as the First of "5. add fingerprint"

b) Second

Same as the Second of "5. add fingerprint"

c) Third

CMD Format :

Byte	1	2	3	4	5	6	7	8
CMD	0xF5	0x06	0	0	0	0	CHK	0xF5

ACK Format :

1) Data head :

Byte	1	2	3	4	5	6	7	8
ACK	0xF5	0x06	Hi(Len)	Low(Len)	ACK_SUCCESS ACK_FAIL ACK_TIMEOUT	0	CHK	0xF5

2) Data packet :

Byte	1	2	3	4	5---Len+1	Len+2	Len+3
ACK	0xF5	0	0	0	Eigenvalues	CHK	0xF5

Notes :

Length of Eigenvalues(Len-) is 193Byte

Data packet is sent when fifth byte of ACK data is ACK_SUCCESS

7. Delete user (CMD/ACK both 8 Byte)

Byte	1	2	3	4	5	6	7	8
CMD	0xF5	0x04	User ID (High 8Bit)	User ID (Low 8Bit)	0	0	CHK	0xF5
ACK	0xF5	0x04	0	0	ACK_SUCCESS ACK_FAIL	0	CHK	0xF5

8. Delete all users (CMD/ACK both 8 Byte)

Byte	1	2	3	4	5	6	7	8
CMD	0xF5	0x05	0	0	0: Delete all users 1/2/3: delete users whose permission is 1/2/3	0	CHK	0xF5
ACK	0xF5	0x05	0	0	ACK_SUCCESS ACK_FAIL	0	CHK	0xF5

9. Query count of users (CMD/ACK both 8 Byte)

Byte	1	2	3	4	5	6	7	8
CMD	0xF5	0x09	0	0	0: Query Count 0xFF: Query Amount	0	CHK	0xF5
ACK	0xF5	0x09	Count /Amount (High 8Bit)	Count /Amount (Low 8Bit)	ACK_SUCCESS ACK_FAIL 0xFF(CMD=0xFF)	0	CHK	0xF5

10. 比对 1:1 (CMD/ACK both 8Byte)

Byte	1	2	3	4	5	6	7	8
CMD	0xF5	0x0B	User ID (High 8 Bit)	User ID (Low 8 Bit)	0	0	CHK	0xF5
ACK	0xF5	0x0B	0	0	ACK_SUCCESS ACK_FAIL ACK_TIMEOUT	0	CHK	0xF5

11. Comparison 1: N (CMD/ACK both 8 Byte)

Byte	1	2	3	4	5	6	7	8
CMD	0xF5	0x0C	0	0	0	0	CHK	0xF5
ACK	0xF5	0x0C	User ID (High 8 Bit)	User ID (Low 8 Bit)	Permission (1/2/3) ACK_NOUSER ACK_TIMEOUT	0	CHK	0xF5

12. Query Permission (CMD/ACK both 8 Byte)

Byte	1	2	3	4	5	6	7	8
CMD	0xF5	0x0A	User ID(High 8Bit)	User ID(Low8Bit)	0	0	CHK	0xF5
ACK	0xF5	0x0A	0	0	Permission (1/2/3) ACK_NOUSER	0	CHK	0xF5

13. Set/Query comparison level (CMD/ACK both 8 Byte)

Byte	1	2	3	4	5	6	7	8
CMD	0xF5	0x28	0	Byte5=0: New Level Byte5=1: 0	0: Set Level 1: Query Level	0	CHK	0xF5
ACK	0xF5	0x28	0	Current Level	ACK_SUCCUSS ACK_FAIL	0	CHK	0xF5

Notes : Comparison level can be 0~9, larger the value, stricter the comparison. Default 5

14. Acquire image and upload (CMD=8 Byte/ACK >8 Byte)

CMD Format :

Byte	1	2	3	4	5	6	7	8
CMD	0xF5	0x24	0	0	0	0	CHK	0xF5

ACK Format :

1) Data head :

Byte	1	2	3	4	5	6	7	8
ACK	0xF5	0x24	Hi(Len)	Low(Len)	ACK_SUCCUSS ACK_FAIL ACK_TIMEOUT	0	CHK	0xF5

2) Data packet

Byte	1	2---Len+1	Len+2	Len+3
ACK	0xF5	Image data	CHK	0xF5

Notes :

In DSP module, the pixels of fingerprint image are 280*280, every pixel is represented by 8 bits. When uploading, DSP is skip pixels sampling in horizontal/vertical direction to reduce data size, so that the image became 140*140, and just take the high 4 bits of pixel. each two pixels composited into one byte for transferring (previous pixel high 4-bit, last pixel low 4-pixe).

Transmission starts line by line from the first line, each line starts from the first pixel, totally transfer 140* 140/ 2 bytes of data.

Data length of image is fixed of 9800 bytes.

15. Acquire image and upload eigenvalues (CMD=8 Byte/ACK > 8Byte)

CMD Format :

Byte	1	2	3	4	5	6	7	8
CMD	0xF5	0x23	0	0	0	0	CHK	0xF5

ACK Format :

1) Data head :

Byte	1	2	3	4	5	6	7	8
ACK	0xF5	0x23	Hi(Len)	Low(Len)	ACK_SUCCUSS ACK_FAIL ACK_TIMEOUT	0	CHK	0xF5

2) Data packet

Byte	1	2	3	4	5---Len+1	Len+2	Len+3
ACK	0xF5	0	0	0	Eigenvalues	CHK	0xF5

Notes : Length of Eigenvalues (Len -3) is 193 bytes.

16. Download eigenvalues and compare with fingerprint acquired (CMD >8 Byte/ACK=8 Byte)

CMD Format :

1) Data head :

Byte	1	2	3	4	5	6	7	8
CMD	0xF5	0x44	Hi(Len)	Low(Len)	0	0	CHK	0xF5

2) Data packet

Byte	1	2	3	4	5---Len+1	Len+2	Len+3
ACK	0xF5	0	0	0	Eigenvalues	CHK	0xF5

Notes : Length of Eigenvalues (Len -3) is 193 bytes.

ACK Format :

Byte	1	2	3	4	5	6	7	8
ACK	0xF5	0x44	0	0	ACK_SUCCUSS ACK_FAIL ACK_TIMEOUT	0	CHK	0xF5

17. Download eigenvalues and comparison 1:1 (CMD >8 Byte/ACK=8 Byte)

CMD Format :

1) Data head :

Byte	1	2	3	4	5	6	7	8
CMD	0xF5	0x42	Hi(Len)	Low(Len)	0	0	CHK	0xF5

2) Data packet

Byte	1	2	3	4	5---Len+1	Len+2	Len+2
ACK	0xF5	User ID (High 8 Bit)	User ID (Low 8 Bit)	0	Eigenvalues	CHK	0xF5

Notes : Length of Eigenvalues (Len -3) is 193 bytes.

ACK Format :

Byte	1	2	3	4	5	6	7	8
ACK	0xF5	0x43	0	0	ACK_SUCCUSS ACK_FAIL	0	CHK	0xF5

18. Download eigenvalues and comparison 1:N (CMD >8 Byte/ACK=8 Byte)

CMD Format :

1) Data head :

Byte	1	2	3	4	5	6	7	8
CMD	0xF5	0x43	Hi(Len)	Low(Len)	0	0	CHK	0xF5

2) Data packet

Byte	1	2	3	4	5---Len+1	Len+2	Len+2
ACK	0xF5	0	0	0	Eigenvalues	CHK	0xF5

Notes : Length of Eigenvalues (Len -3) is 193 bytes.

ACK Format :

Byte	1	2	3	4	5	6	7	8
ACK	0xF5	0x43	User ID (High 8 Bit)	User ID (Low 8 Bit)	Permission (1/2/3) ACK_NOUSER	0	CHK	0xF5

19. Upload eigenvalues from DSP model CMD=8 Byte/ACK >8 Byte)

CMD Format :

Byte	1	2	3	4	5	6	7	8
CMD	0xF5	0x31	User ID (High 8 Bit)	User ID (Low 8 Bit)	0	0	CHK	0xF5

ACK Format :

1) Data head :

Byte	1	2	3	4	5	6	7	8
ACK	0xF5	0x31	Hi(Len)	Low(Len)	ACK_SUCCUSS ACK_FAIL ACK_NOUSER	0	CHK	0xF5

2) Data packet

Byte	1	2	3	4	5---Len+1	Len+2	Len+3
ACK	0xF5	User ID (High 8 Bit)	User ID(Low 8 Bit)	Permission (1/2/3)	Eigenvalues	CHK	0xF5

Notes : Length of Eigenvalues (Len -3) is 193 bytes.

20. Download eigenvalues and save as User ID to DSP (CMD>8 Byte/ACK =8 Byte)

CMD Format :

1) Data head :

Byte	1	2	3	4	5	6	7	8
CMD	0xF5	0x41	Hi(Len)	Low(Len)	0	0	CHK	0xF5

2) Data packet

Byte	1	2	3	4	5---Len+1	Len+2	Len+3
ACK	0xF5	User ID (High 8 Bit)	User ID (Low8 Bit)	Permission (1/2/3)	Eigenvalues	CHK	0xF5

Notes : Length of Eigenvalues (Len -3) is 193 bytes.

ACK Format :

Byte	1	2	3	4	5	6	7	8
ACK	0xF5	0x41	User ID (High 8 Bit)	User ID (Low 8 Bit)	ACK_SUCCESS ACK_FAIL	0	CHK	0xF5

21. Query information (ID and permission) of all users added (CMD=8 Byte/ACK >8Byte)

CMD Format :

Byte	1	2	3	4	5	6	7	8
CMD	0xF5	0x2B	0	0	0	0	CHK	0xF5

ACK Format :

1) Data head :

Byte	1	2	3	4	5	6	7	8
ACK	0xF5	0x2B	Hi(Len)	Low(Len)	ACK_SUCCUSS ACK_FAIL	0	CHK	0xF5

2) Data packet

Byte	1	2	3	4---Len+1	Len+2	Len+3
ACK	0xF5	User ID (High 8 Bit)	User ID (Low 8 Bit)	User information (User ID and permission)	CHK	0xF5

Notes :

Data length of Data packet (Len) is "3*User ID+2"

User information Format :

Byte	4	5	6	7	8	9	...
Data	User ID1 (High 8 Bit)	User ID1 (Low 8 Bit)	User 1 Permission (1/2/3)	User ID2 (High 8 Bit)	User ID2 (Low 8 Bit)	User 2 Permission (1/2/3)	...

22. Set/Query fingerprint capture timeout (CMD/ACK both 8 Byte)

Byte	1	2	3	4	5	6	7	8
CMD	0xF5	0x2E	0	Byte5=0: timeout Byte5=1: 0	0: Set timeout 1: query timeout	0	CHK	0xF5
ACK	0xF5	0x2E	0	timeout	ACK_SUCCUSS ACK_FAIL	0	CHK	0xF5

Notes :

Range of fingerprint waiting timeout (tout) value is 0-255. If the value is 0, the fingerprint acquisition process will keep continue if no fingerprints press on; If the value is not 0, the system will exist for reason of timeout if no fingerprints press on in time tout * T0.

Note: T0 is the time required for collecting/processing an image, usually 0.2- 0.3 s.

COMMUNICATION PROCESS

ADD FINGERPRINT

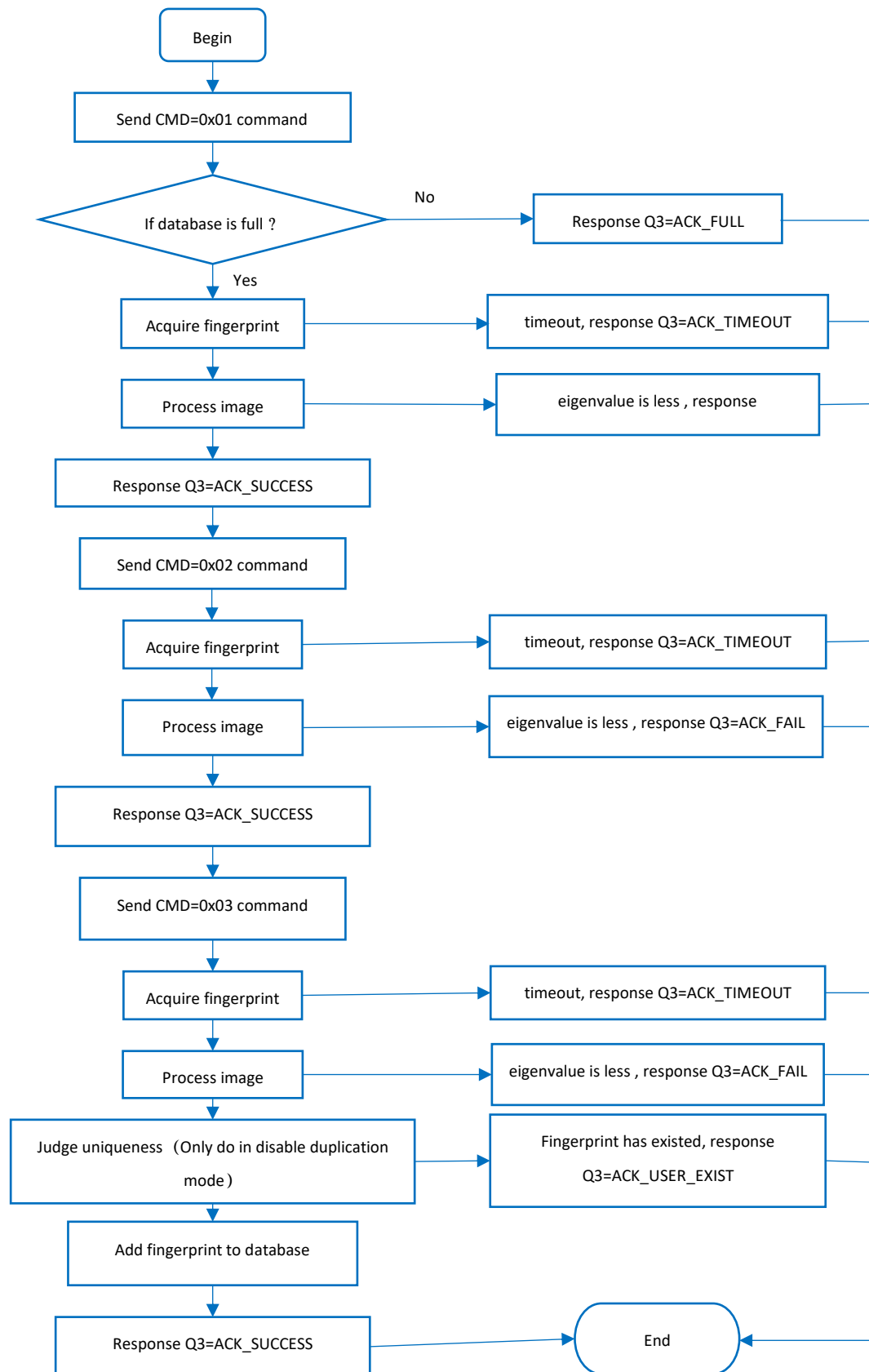

DELETE USER

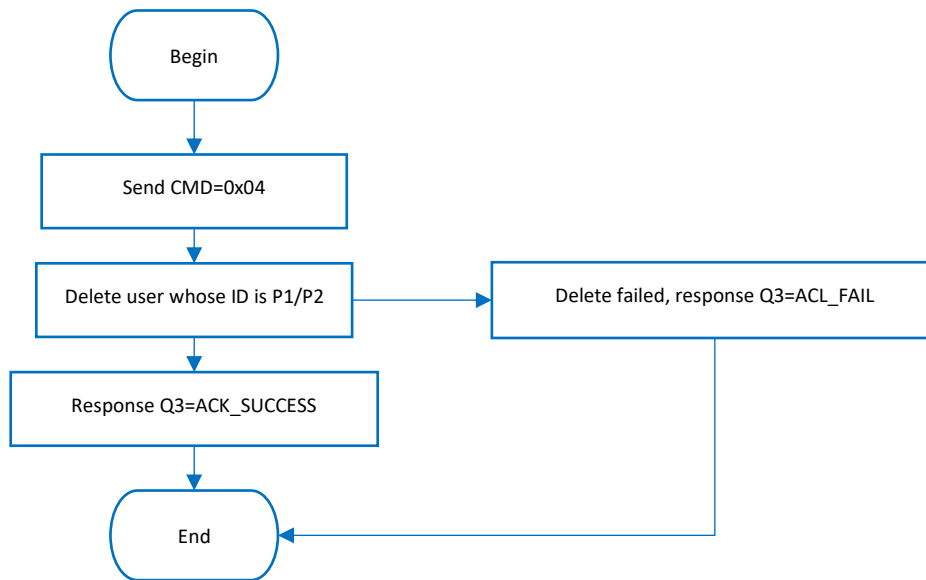

DELETE ALL USERS

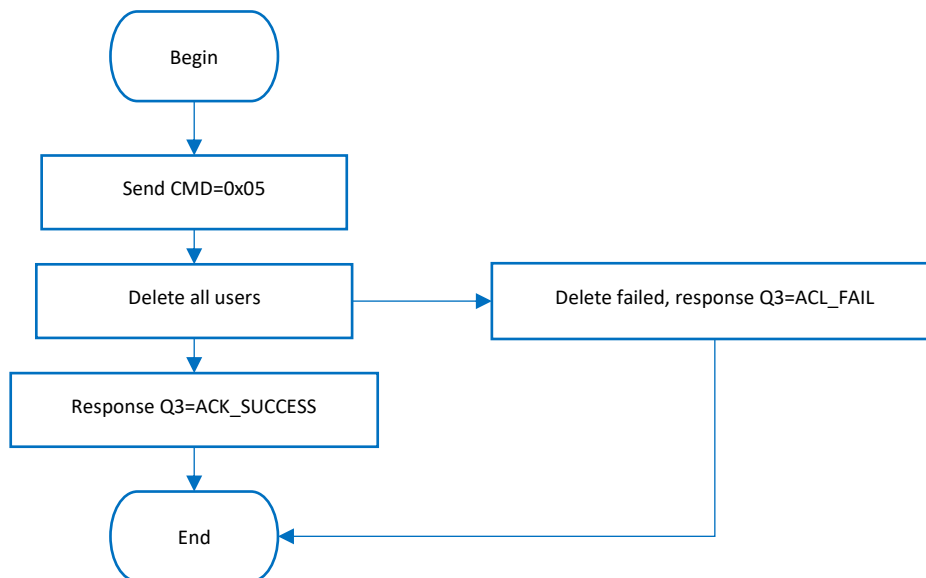

ACQUIRE IMAGE AND UPLOAD EIGENVALUE

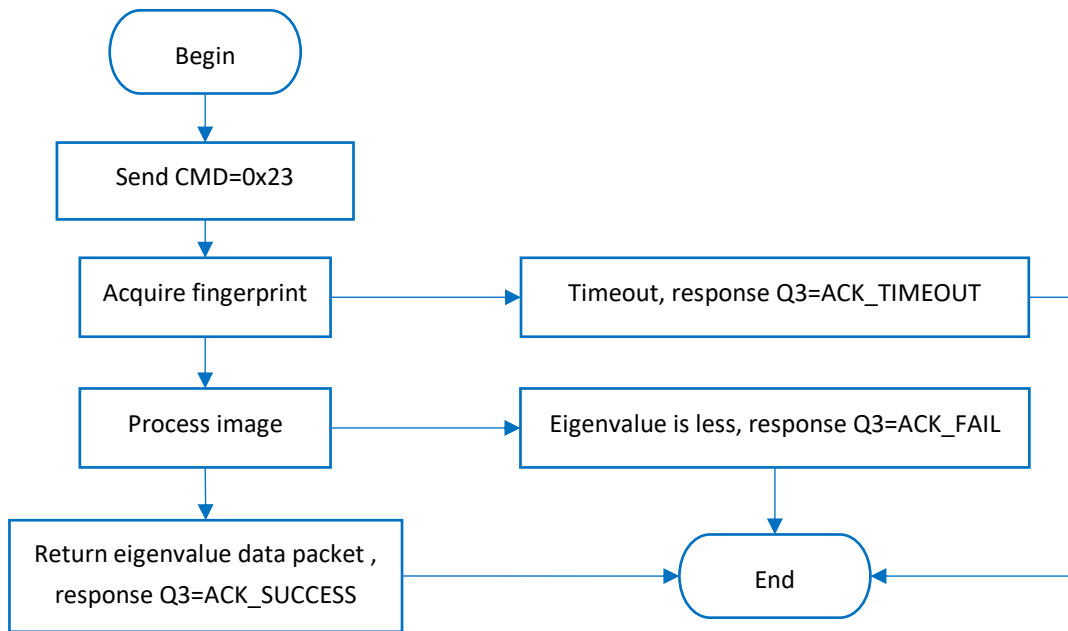

USER GUIDES

If you want to connect the fingerprint module to PC, you need to buy one UART to USB module. We recommend you use Waveshare [FT232 USB UART Board \(micro\)](#) module.

If you want to connect the fingerprint module to development board like Raspberry Pi, if the working level of your board is 3.3V, you can directly connect it to UART and GPIO pins of your board. If it is 5V, please add level convert module/circuitry.

CONNECT TO PC

HARDWARE CONNECTION

You need:

- UART Fingerprint Sensor (C)*1
- FT232 USB UART Board *1
- micro USB cable *1

Connect the fingerprint module and FT232 USB UART Board to PC

UART Fingerprint Sensor (C)	FT232 USB UART Board
Vcc	Vcc
GND	GND
RX	TX
TX	RX
RST	NC
WAKE	NC

TESTING

- Download UART Fingerprint Sensor test software from wiki
- Open software and choose the correct COM port. (The software can only support COM1~COM8, if the COM port in your PC is out of this range, please modify it)
- Testing

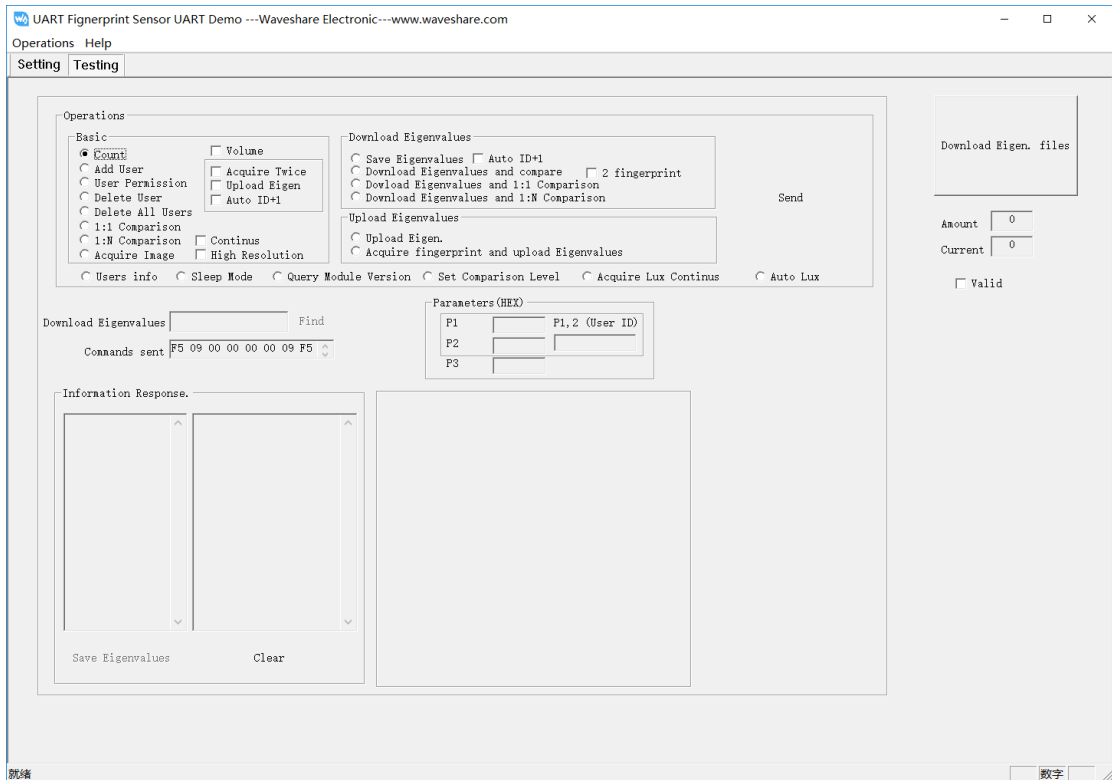

There are several functions provided in Testing interface

1. Query Count
Choose **Count**, then click **Send**. The count of users is returned and display in **Information Response** interface
2. Add User
Choose **Add User**, check **Acquire Twice** and **Auto ID+1**, type the ID (**P1** and **P2**) and permission (**P3**), then click **Send**. Finally, touch sensor to acquire fingerprint.
3. Delete user
Choose **Delete User**, type the ID (**P1** and **P2**) and permission (**P3**), then click **Send**.
4. Delete All Users
Choose **Delete All Users**, then click **Send**
5. Comparison 1:1
Choose **1:1 Comparison**, type the ID (**P1** and **P2**) and permission (**P3**), then click **Send**.
6. Comparison 1:N
Choose **1:N Comparison**, then click **Send**.

...

For more function, please test it. (Some of the functions are unavailable for this module)

CONNECT TO XNUCLEO-F103RB

We provide a demo codes for XNCULEO-F103RB, you can download from wiki

UART Fingerprint Sensor (C)	XNUCLEO-F103RB
Vcc	3.3V
GND	GND
RX	PA9
TX	PA10
RST	PB5
WAKE	PB3

Note: About the pins, please refer to [Interface](#) above

1. Connect UART Fingerprint Sensor (C) to XNUCLEO_F103RB, and connect programmer
2. Open project (demo code) by keil5 software
3. Check if programmer and device are recognized normally
4. Compile and download
5. Connect XNUCLEO-F103RB to PC by USB cable, open Serial assistance software, set COM port: 115200, 8N1

Type commands to test module according to information returned.

CONNECT TO RASPBERRY PI

We provide python example for Raspberry Pi, you can download it from wiki

Before you use the example, you should enable serial port of Raspberry Pi first:

Input command on Terminal: `sudo raspi-config`

Choose: Interfacing Options -> Serial -> No -> Yes

Then reboot.

UART Fingerprint Sensor (C)	Raspberry Pi
Vcc	3.3V
GND	GND
RX	14 (BCM) – PIN 8 (Board)
TX	15 (BCM) – PIN 10 (Board)
RST	24 (BCM) – PIN 18 (Board)
WAKE	23 (BCM) – PIN 16 (Board)

1. Connect fingerprint module to Raspberry Pi
2. Download demo code to Raspberry Pi:
`wget https://www.waveshare.com/w/upload/9/9d/UART-Fignerprint-RaspberryPi.tar.gz`
3. unzip it
`tar zxvf UART-Fignerprint-RaspberryPi.tar.gz`
4. Run the example
`cd UART-Fignerprint-RaspberryPi/`
`sudo python main.py`
5. Following guides to test the module.