

# INTERFACE

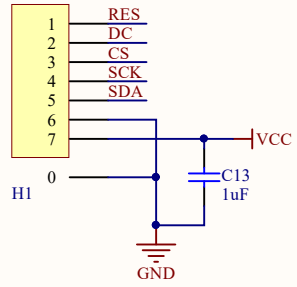

# POWER\_VPP

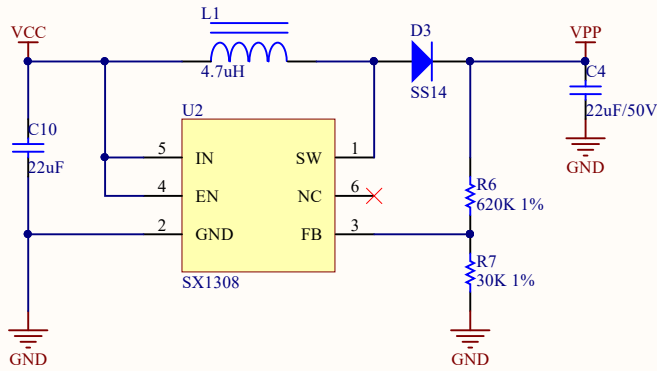

# INTERFACE\_OLED

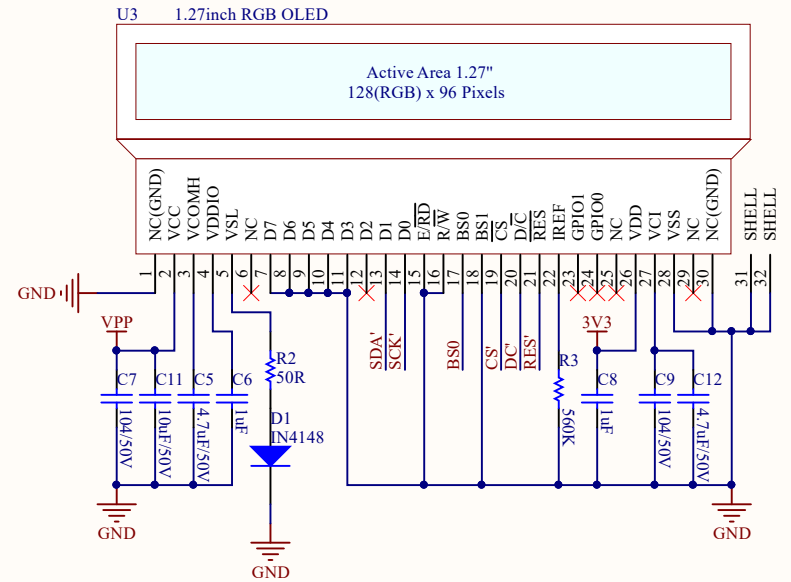

BS0	GND	3V3
MODE	4-WIRE SPI	3-WIRE SPI

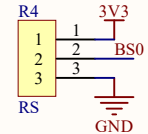

# POWER\_OLED

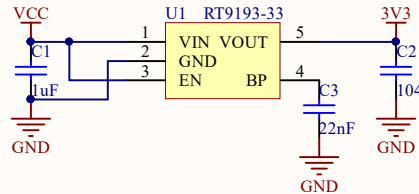

# LEVEL SWITCH

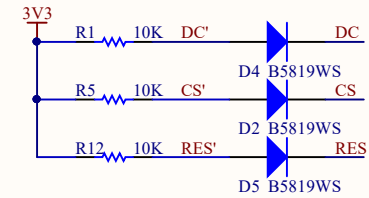
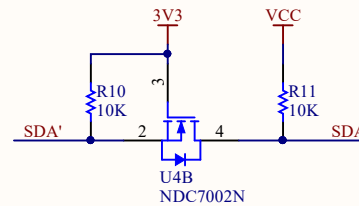
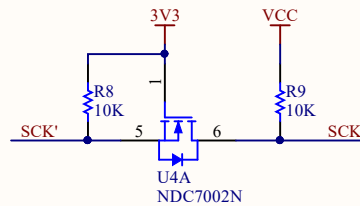

# 1.27inch RGB OLED Module

