

4.3inch LCD

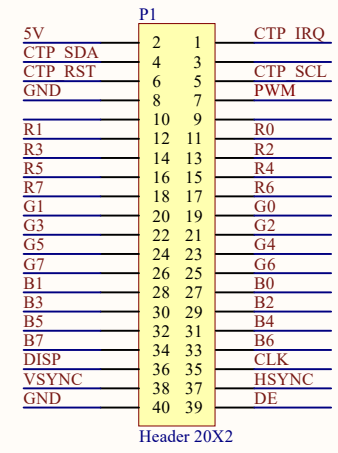

RGB Header Interface

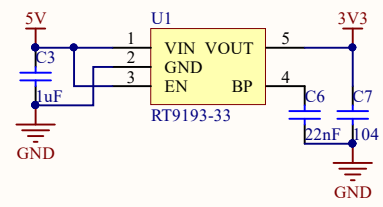

Power

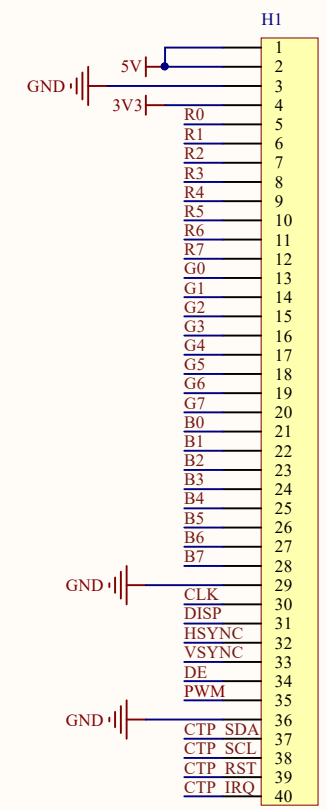

RGB Cable Interface

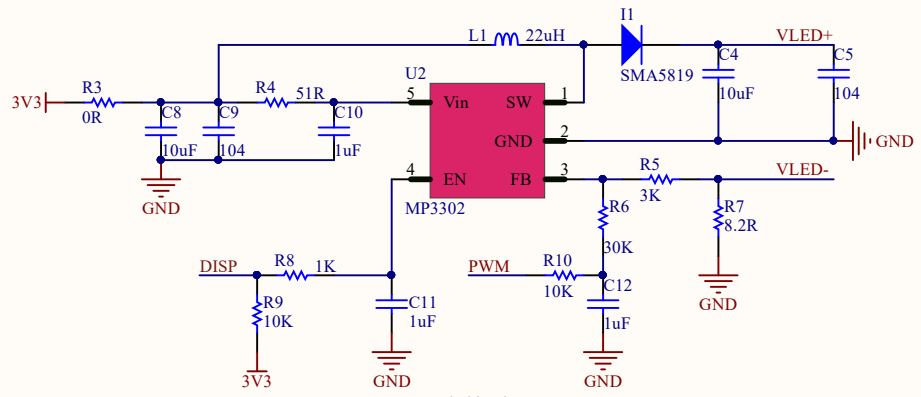

LCD Backlight Power

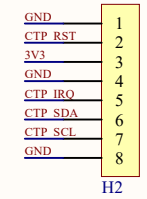

Touch Panel interface



4.3inch Capacitive Touch LCD

R = 6.2 106.00

RGB Interface

1	5V	21	B0
2	5V	22	B1
3	GND	23	B2
4	3.3V	24	B3
5	R0	25	B4
6	R1	26	B5
7	R2	27	B6
8	R3	28	B7
9	R4	29	GND
10	R5	30	CLK
11	R6	31	DISP
12	R7	32	HSYNC
13	G0	33	VSYNC
14	G1	34	DE
15	G2	35	PWM
16	G3	36	GND
17	G4	37	SDA
18	G5	38	SCL
19	G6	39	RST
20	G7	40	IRQ

4.3inch Capacitive Touch LCD
800×480 Pixel

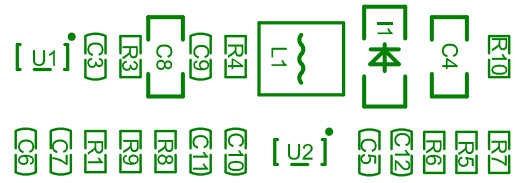

LCD Interface



5V	IRQ
SDA	NC
RST	SCL
GND	PWM
NC	NC
R1	R0
R3	R2
R5	R4
R7	R6
G1	G0
G3	G2
G5	G4
G7	G6
B1	B0
B3	B2
B5	B4
B7	B6
DISP	CLK
VSYNC	HSYNC
GND	DE

Touch Panel Interface

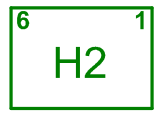

1	RST
2	3.3V
3	GND
4	IRQ
5	SDA
6	SCL

RGB Interface

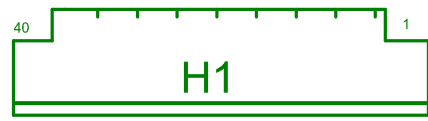

Unit:mm

68.00

