

DS18B20

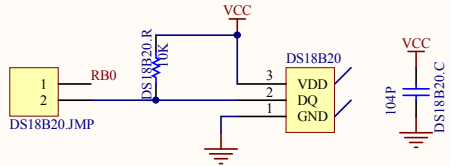

JOYSTICK

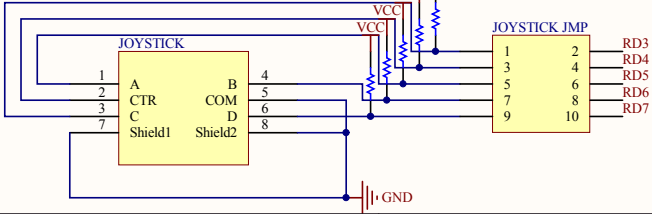

User Keys

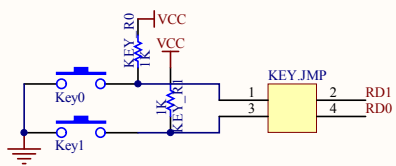

BUZZER

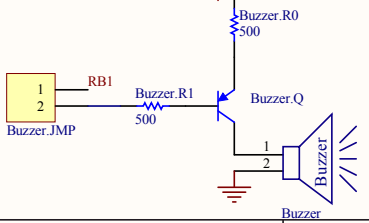

PS2

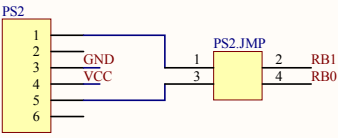

REMOET

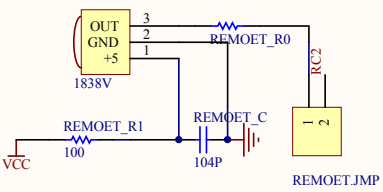

8LEDs

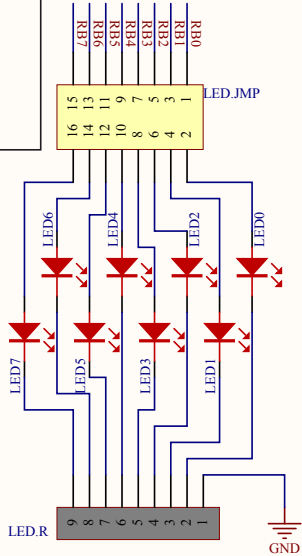

RESET

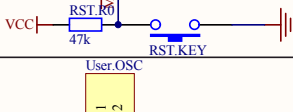

MCU

PIC16F877A/18F4520			
MCLR/VPP	1	RB7	40
RA0	2	RB6	39
RA1	3	RB5	38
RA2	4	RB4	37
RA3	5	RB3	36
RA4	6	RB2	35
RA5	7	RB1	34
RE0	8	RB0	33
RE1	9	VDD	32
RE2	10	VSS	31
OSC1	13	RD7	30
OSC2	14	RD6	29
OSC2	15	RD5	28
RC0	16	RD4	27
RC1	17	RD3	26
RC2	18	RD2	25
RC3	19	RD1	24
RD0	20	RD0	23
		RD3	22
		RD2	21
		RD1	20

8 I/Os

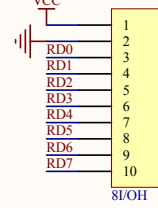

USART

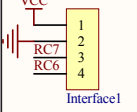

I2C

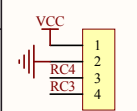

ICSP download

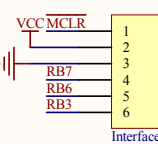

OSCILLATOR

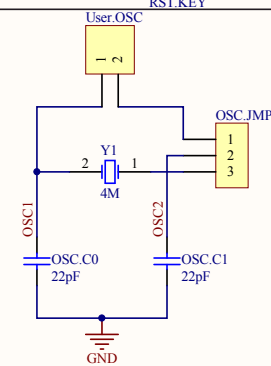

LCD22

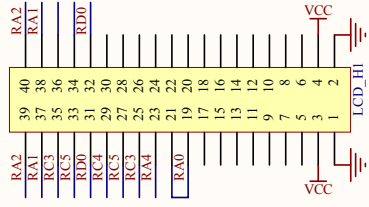

LCD1602

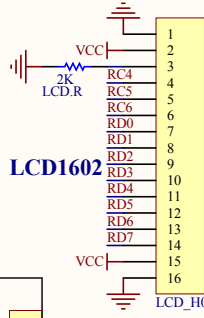

16I/Os ADC

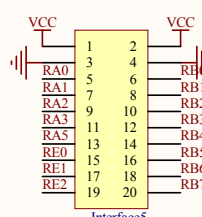

8I/Os SPI Capture Timer PWM

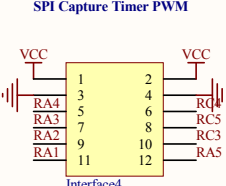

Power

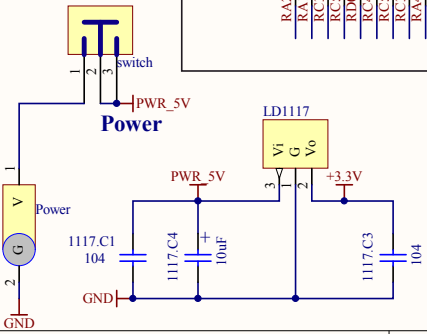

Title		
Size	Number	Revision
A3		
Date:	2013-11-14	Sheet of
File:	E:\PCB\Open16F877A_18F4520.SCHDOC	Drawn By: